

# NPN Silicon Epitaxial Transistor

## BCP56 Series

These NPN Silicon Epitaxial transistors are designed for use in audio amplifier applications. The device is housed in the SOT-223 package, which is designed for medium power surface mount applications.

### Features

- High Current: 1.0 A
- The SOT-223 package can be soldered using wave or reflow. The formed leads absorb thermal stress during soldering, eliminating the possibility of damage to the die
- Available in 12 mm Tape and Reel  
Use BCP56T1G to Order the 7 inch/1000 Unit Reel  
Use BCP56T3G to Order the 13 inch/4000 Unit Reel
- PNP Complement is BCP53T1G
- S and NSV Prefix for Automotive and Other Applications Requiring Unique Site and Control Change Requirements; AEC-Q101 Qualified and PPAP Capable
- These Devices are Pb-Free, Halogen Free/BFR Free and are RoHS Compliant

### MAXIMUM RATINGS (T<sub>C</sub> = 25°C unless otherwise noted)

Rating	Symbol	Value	Unit
Collector-Emitter Voltage	V <sub>CEO</sub>	80	Vdc
Collector-Base Voltage	V <sub>CBO</sub>	100	Vdc
Emitter-Base Voltage	V <sub>EBO</sub>	5	Vdc
Collector Current	I <sub>C</sub>	1	Adc
Collector Current - Peak (Note 1)	I <sub>CM</sub>	2	Adc
Total Power Dissipation @ T <sub>A</sub> = 25°C (Note 2) Derate above 25°C	P <sub>D</sub>	1.5 12	W mW/°C
Operating and Storage Temperature Range	T <sub>J</sub> , T <sub>stg</sub>	-65 to 150	°C

### THERMAL CHARACTERISTICS

Characteristic	Symbol	Max	Unit
Thermal Resistance, Junction-to-Ambient (surface mounted)	R <sub>θJA</sub>	83.3	°C/W
Maximum Temperature for Soldering Purposes Time in Solder Bath	T <sub>L</sub>	260 10	°C Sec

Stresses exceeding those listed in the Maximum Ratings table may damage the device. If any of these limits are exceeded, device functionality should not be assumed, damage may occur and reliability may be affected.

1. Reference SOA curve.
2. Device mounted on a FR-4 glass epoxy printed circuit board 1.575 in x 1.575 in x 0.0625 in; mounting pad for the collector lead = 0.93 sq in.

## MEDIUM POWER NPN SILICON HIGH CURRENT TRANSISTOR SURFACE MOUNT

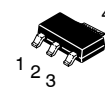
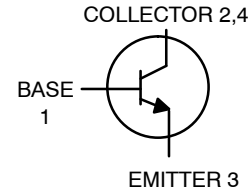

SOT-223  
CASE 318E  
STYLE 1

### MARKING DIAGRAM

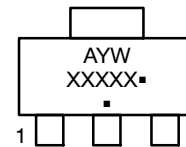

XXXXX = Specific Device Code  
A = Assembly Location  
Y = Year  
W = Work Week  
▪ = Pb-Free Package  
(Note: Microdot may be in either location)

### ORDERING INFORMATION

See detailed ordering, marking and shipping information in the package dimensions section on page 5 of this data sheet.

## BCP56 Series

### ELECTRICAL CHARACTERISTICS ( $T_A = 25^\circ\text{C}$ unless otherwise noted)

Characteristics	Symbol	Min	Typ	Max	Unit
-----------------	--------	-----	-----	-----	------

#### OFF CHARACTERISTICS

Collector–Base Breakdown Voltage ( $I_C = 100\ \mu\text{Adc}$ , $I_E = 0$ )	$V_{(BR)CBO}$	100	–	–	Vdc
Collector–Emitter Breakdown Voltage ( $I_C = 1.0\ \text{mAdc}$ , $I_B = 0$ )	$V_{(BR)CEO}$	80	–	–	Vdc
Emitter–Base Breakdown Voltage ( $I_E = 10\ \mu\text{Adc}$ , $I_C = 0$ )	$V_{(BR)EBO}$	5.0	–	–	Vdc
Collector–Base Cutoff Current ( $V_{CB} = 30\ \text{Vdc}$ , $I_E = 0$ )	$I_{CBO}$	–	–	100	nAdc
Emitter–Base Cutoff Current ( $V_{EB} = 5.0\ \text{Vdc}$ , $I_C = 0$ )	$I_{EBO}$	–	–	10	$\mu\text{Adc}$

#### ON CHARACTERISTICS (Note 3)

DC Current Gain ( $I_C = 5.0\ \text{mA}$ , $V_{CE} = 2.0\ \text{V}$ ) ( $I_C = 150\ \text{mA}$ , $V_{CE} = 2.0\ \text{V}$ )  ( $I_C = 500\ \text{mA}$ , $V_{CE} = 2.0\ \text{V}$ )	$h_{FE}$	25 40 63 100 25	– – – – –	– 250 160 250 –	–
Collector–Emitter Saturation Voltage ( $I_C = 500\ \text{mAdc}$ , $I_B = 50\ \text{mAdc}$ )	$V_{CE(sat)}$	–	–	0.5	Vdc
Base–Emitter On Voltage ( $I_C = 500\ \text{mAdc}$ , $V_{CE} = 2.0\ \text{Vdc}$ )	$V_{BE(on)}$	–	–	1.0	Vdc

#### SWITCHING CHARACTERISTICS

Rise Time ( $V_{CC} = 30\ \text{Vdc}$ , $I_C = 150\ \text{mA}$ , $I_{B1} = 15\ \text{mA}$ )	$t_r$	–	14	–	ns
Delay Time ( $V_{CC} = 30\ \text{Vdc}$ , $I_C = 150\ \text{mA}$ , $I_{B1} = 15\ \text{mA}$ )	$t_d$	–	9	–	ns
Storage Time ( $V_{CC} = 30\ \text{Vdc}$ , $I_C = 150\ \text{mA}$ , $I_{B1} = 15\ \text{mA}$ , $I_{B2} = 15\ \text{mA}$ )	$t_s$	–	714	–	ns
Fall Time ( $V_{CC} = 30\ \text{Vdc}$ , $I_C = 150\ \text{mA}$ , $I_{B1} = 15\ \text{mA}$ , $I_{B2} = 15\ \text{mA}$ )	$t_f$	–	58	–	ns

#### DYNAMIC CHARACTERISTICS

Current–Gain – Bandwidth Product ( $I_C = 10\ \text{mAdc}$ , $V_{CE} = 5.0\ \text{Vdc}$ , $f = 35\ \text{MHz}$ )	$f_T$	–	130	–	MHz
---	-------	---	-----	---	-----

Product parametric performance is indicated in the Electrical Characteristics for the listed test conditions, unless otherwise noted. Product performance may not be indicated by the Electrical Characteristics if operated under different conditions.

3. Pulse Test: Pulse Width  $\leq 300\ \mu\text{s}$ , Duty Cycle  $\leq 2.0\%$

# BCP56 Series

## TYPICAL ELECTRICAL CHARACTERISTICS

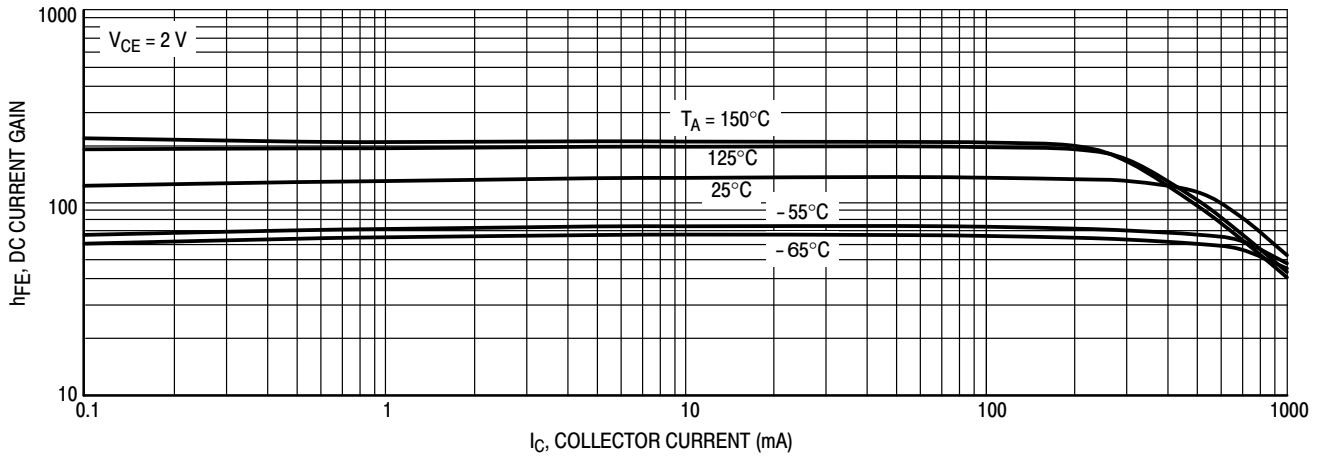

Figure 1. DC Current Gain

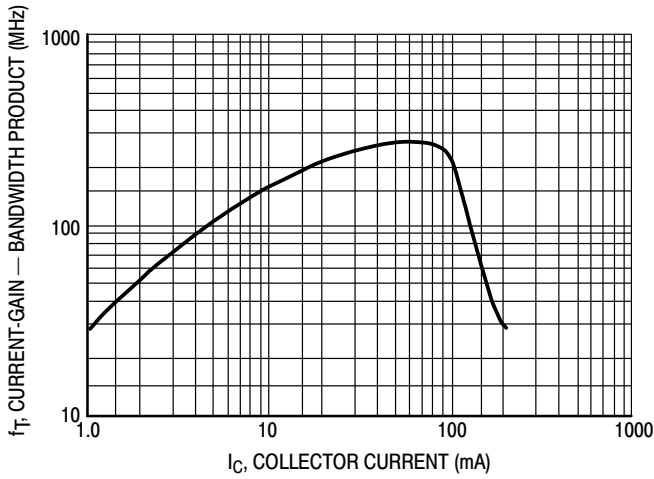

Figure 2. Current-Gain - Bandwidth Product

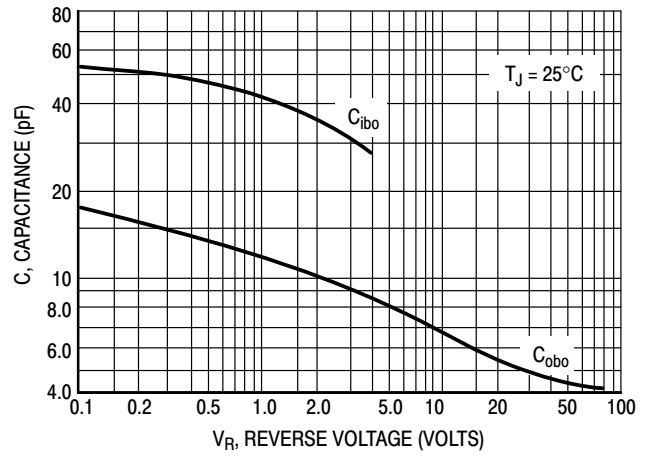

Figure 3. Capacitance

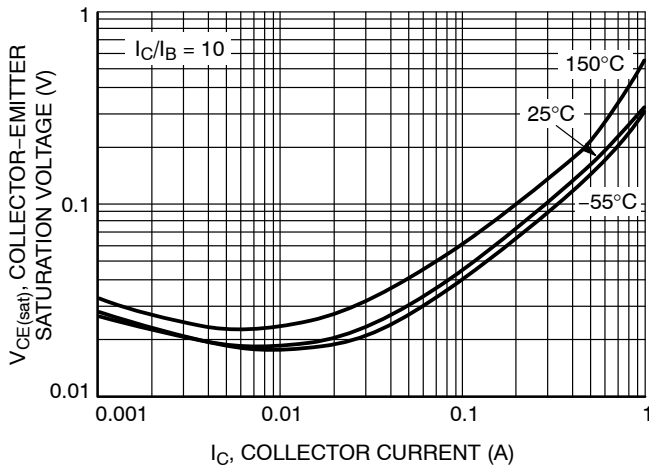

Figure 4. Collector Emitter Saturation Voltage vs. Collector Current

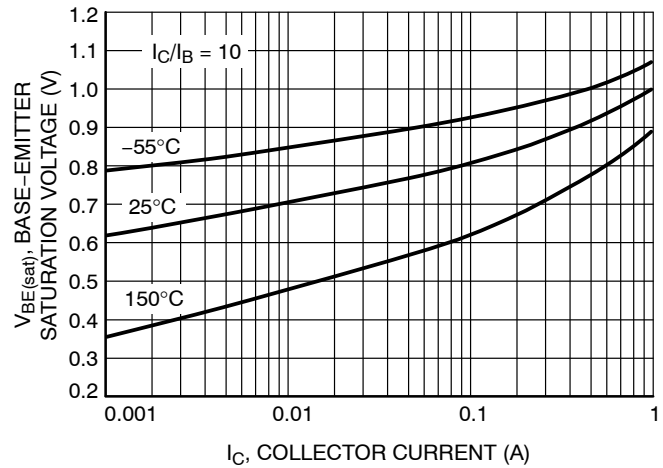
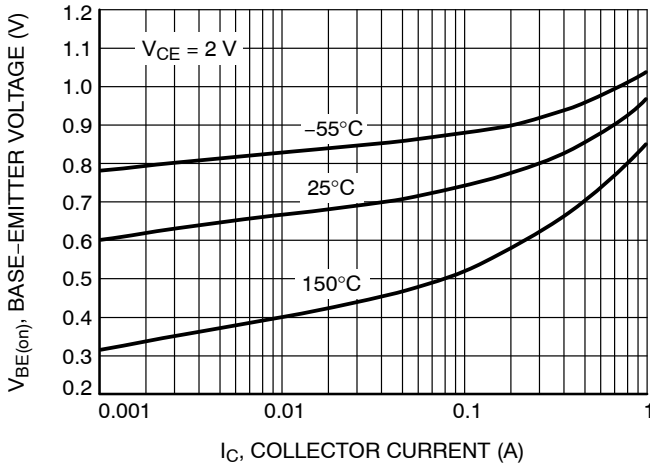

Figure 5. Base Emitter Saturation Voltage vs. Collector Current

# BCP56 Series

## TYPICAL ELECTRICAL CHARACTERISTICS



**Figure 6. Base Emitter Voltage vs. Collector Current**

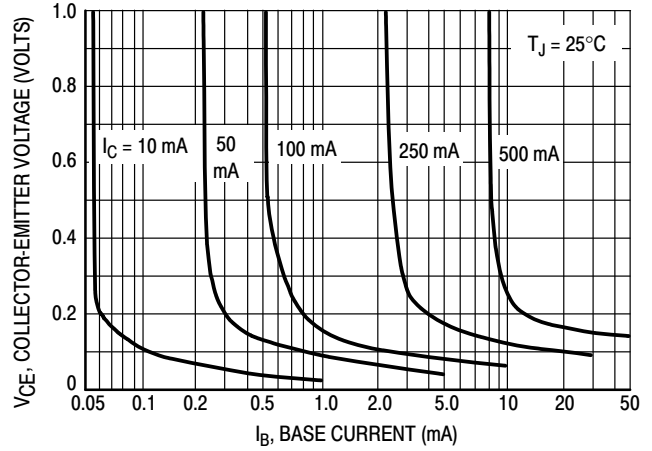

**Figure 7. Collector Saturation Region**

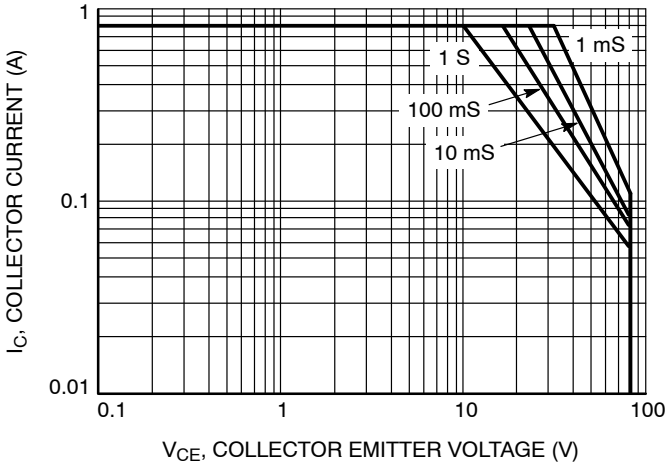

**Figure 8. Safe Operating Area**

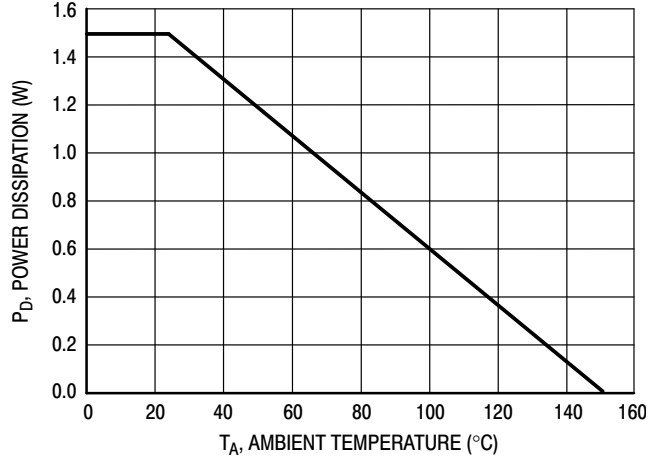

**Figure 9. Power Derating Curve**

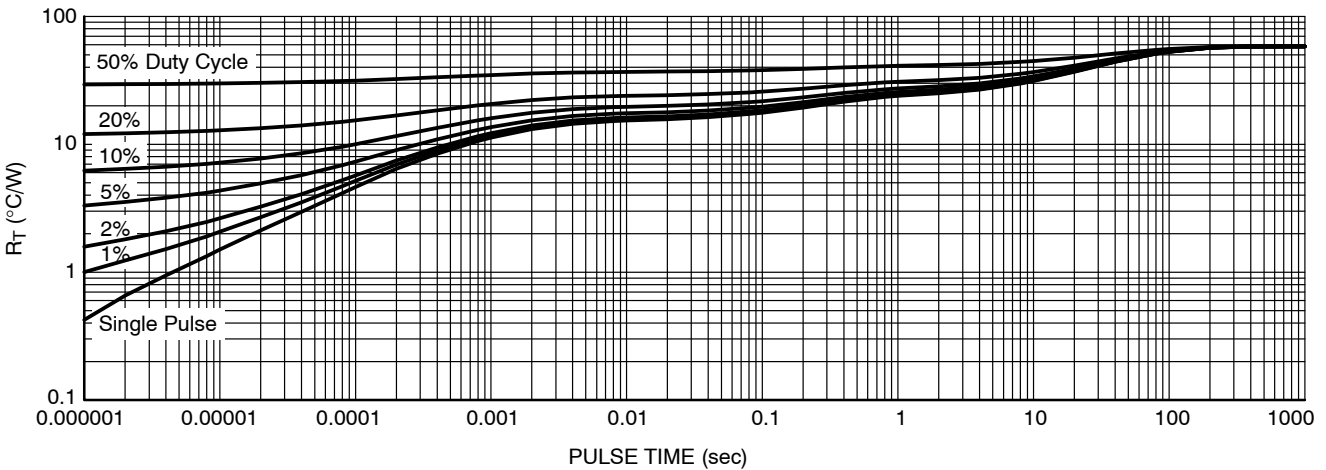

**Figure 10. Thermal Response**

## BCP56 Series

### ORDERING INFORMATION

Device	Marking	Package	Shipping†
BCP56T1G	BH	SOT-223 (Pb-Free)	1000 / Tape & Reel
SBCP56T1G*			
BCP56T3G	BH	SOT-223 (Pb-Free)	4000 / Tape & Reel
SBCP56T3G*			
BCP56-10T1G	BH-10	SOT-223 (Pb-Free)	1000 / Tape & Reel
SBCP56-10T1G*			
BCP56-10T3G	BH-10	SOT-223 (Pb-Free)	4000 / Tape & Reel
NSVBCP56-10T3G*			
BCP56-16T1G	BH-16	SOT-223 (Pb-Free)	1000 / Tape & Reel
SBCP56-16T1G*			
BCP56-16T3G	BH-16	SOT-223 (Pb-Free)	4000 / Tape & Reel
SBCP56-16T3G*			

†For information on tape and reel specifications, including part orientation and tape sizes, please refer to our Tape and Reel Packaging Specifications Brochure, BRD8011/D.

\*S and NSV Prefix for Automotive and Other Applications Requiring Unique Site and Control Change Requirements; AEC-Q101 Qualified and PPAP Capable.

# BCP56 Series

## PACKAGE DIMENSIONS

SOT-223 (TO-261)  
CASE 318E-04  
ISSUE R

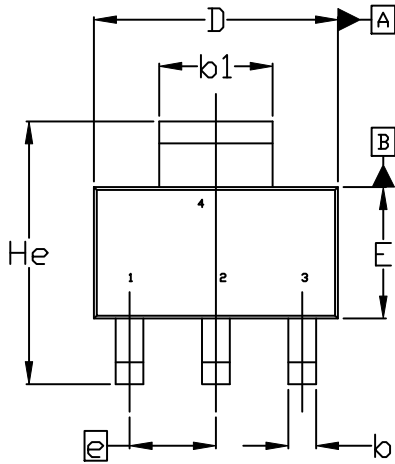

TOP VIEW

$\oplus 0.10 \text{ (M) C A B}$

NOTE 5

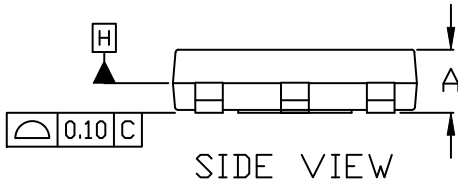

SIDE VIEW

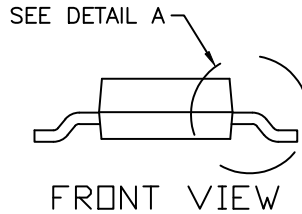

FRONT VIEW

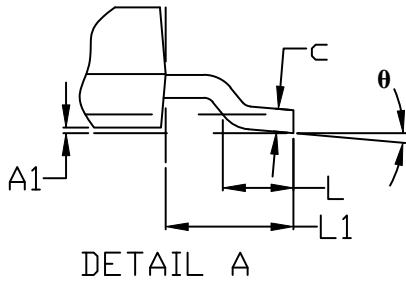

DETAIL A

NOTES:

1. DIMENSIONING AND TOLERANCING PER ASME Y14.5M, 1994.
2. CONTROLLING DIMENSION: MILLIMETERS
3. DIMENSIONS D & E DO NOT INCLUDE MOLD FLASH, PROTRUSIONS OR GATE BURRS. MOLD FLASH, PROTRUSIONS OR GATE BURRS SHALL NOT EXCEED 0.200MM PER SIDE.
4. DATUMS A AND B ARE DETERMINED AT DATUM H.
5. A1 IS DEFINED AS THE VERTICAL DISTANCE FROM THE SEATING PLANE TO THE LOWEST POINT OF THE PACKAGE BODY.
6. POSITIONAL TOLERANCE APPLIES TO DIMENSIONS b AND b1.

DIM	MILLIMETERS		
	MIN.	NOM.	MAX.
A	1.50	1.63	1.75
A1	0.02	0.06	0.10
b	0.60	0.75	0.89
b1	2.90	3.06	3.20
c	0.24	0.29	0.35
D	6.30	6.50	6.70
E	3.30	3.50	3.70
e	2.30 BSC		
L	0.20	---	---
L1	1.50	1.75	2.00
He	6.70	7.00	7.30
$\theta$	0°	---	10°

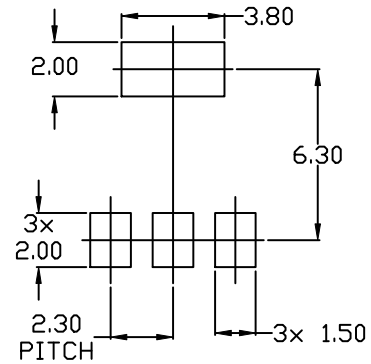

RECOMMENDED MOUNTING FOOTPRINT

# BCP56 Series

**onsemi**, **Onsemi**, and other names, marks, and brands are registered and/or common law trademarks of Semiconductor Components Industries, LLC dba "**onsemi**" or its affiliates and/or subsidiaries in the United States and/or other countries. **onsemi** owns the rights to a number of patents, trademarks, copyrights, trade secrets, and other intellectual property. A listing of **onsemi**'s product/patent coverage may be accessed at [www.onsemi.com/site/pdf/Patent-Marking.pdf](http://www.onsemi.com/site/pdf/Patent-Marking.pdf). **onsemi** reserves the right to make changes at any time to any products or information herein, without notice. The information herein is provided "as-is" and **onsemi** makes no warranty, representation or guarantee regarding the accuracy of the information, product features, availability, functionality, or suitability of its products for any particular purpose, nor does **onsemi** assume any liability arising out of the application or use of any product or circuit, and specifically disclaims any and all liability, including without limitation special, consequential or incidental damages. Buyer is responsible for its products and applications using **onsemi** products, including compliance with all laws, regulations and safety requirements or standards, regardless of any support or applications information provided by **onsemi**. "Typical" parameters which may be provided in **onsemi** data sheets and/or specifications can and do vary in different applications and actual performance may vary over time. All operating parameters, including "Typicals" must be validated for each customer application by customer's technical experts. **onsemi** does not convey any license under any of its intellectual property rights nor the rights of others. **onsemi** products are not designed, intended, or authorized for use as a critical component in life support systems or any FDA Class 3 medical devices or medical devices with a same or similar classification in a foreign jurisdiction or any devices intended for implantation in the human body. Should Buyer purchase or use **onsemi** products for any such unintended or unauthorized application, Buyer shall indemnify and hold **onsemi** and its officers, employees, subsidiaries, affiliates, and distributors harmless against all claims, costs, damages, and expenses, and reasonable attorney fees arising out of, directly or indirectly, any claim of personal injury or death associated with such unintended or unauthorized use, even if such claim alleges that **onsemi** was negligent regarding the design or manufacture of the part. **onsemi** is an Equal Opportunity/Affirmative Action Employer. This literature is subject to all applicable copyright laws and is not for resale in any manner.

## PUBLICATION ORDERING INFORMATION

### LITERATURE FULFILLMENT:

Email Requests to: [orderlit@onsemi.com](mailto:orderlit@onsemi.com)

**onsemi** Website: [www.onsemi.com](http://www.onsemi.com)

### TECHNICAL SUPPORT

**North American Technical Support:**  
Voice Mail: 1 800-282-9855 Toll Free USA/Canada  
Phone: 011 421 33 790 2910

**Europe, Middle East and Africa Technical Support:**

Phone: 00421 33 790 2910

For additional information, please contact your local Sales Representative

