

Click [here](#) to ask about the production status of specific part numbers.

MAX33250E/MAX33251E

600V Isolated 2Tx/2Rx and 1Tx/1Rx RS-232 Transceiver with $\pm 15\text{kV}$ ESD and Integrated Capacitors

General Description

The MAX33250E and MAX33251E are isolated 2Tx/2Rx and 1Tx/1Rx RS-232 transceivers, respectively, with a galvanic isolation of 600V_{RMS} (60sec) between the logic UART side and field side. The isolation barrier protects the logic UART side from electrical transient strikes from the field side. It also breaks ground loops and large differences in ground potentials between the two sides that can potentially corrupt the receiving and sending of data. The MAX33250E and MAX33251E conform to the EIA/TIA-232E standard and operate at data rates up to 1Mbps.

The isolated RS-232 transceivers have integrated charge pumps and an inverter to eliminate the need for a high positive and negative voltage supply. Both devices also have integrated charge pump and inverter capacitors to help further reduce PCB space. The supply pin V_{CCA} on the UART logic side operates from a dual voltage supply from +3V to +5.5V. V_{CCB} also operates from +3V to +5.5V, simplifying power requirements and enabling level translation between the two voltages. The transmitters and receivers on the field side of these devices are rated for $\pm 15\text{kV}$ of ESD HBM protection, suitable for applications where RS-232 cables are frequently worked on.

Both are available in a 12-pin, 6mm x 6mm LGA package and operate over the -40°C to $+85^{\circ}\text{C}$ temperature range.

Applications

- Diagnostics Equipment
- POS Systems
- Industrial Equipment
- GPS Equipment
- Communication Systems
- Medical Equipment

Benefits and Features

- High Integration Saves Space and Simplifies Designs
 - Integrated Charge Pumps and Inverter Eliminates Extra Power Supplies
 - Four Internal Capacitors Saves PCB Space
 - Integrated Isolator Saves Up to 63% Versus a Discrete Solution
- Integrated Protection for Robust Communications
 - 600V_{RMS} Withstand Isolation Voltage for 60 Seconds (V_{ISO})
 - 200V_{RMS} Working Voltage for >50 years (V_{IOWM})
 - Integrated $\pm 15\text{kV}$ ESD Human Body Model (HBM)

Ordering Information appears at end of data sheet.

Simplified Block Diagram

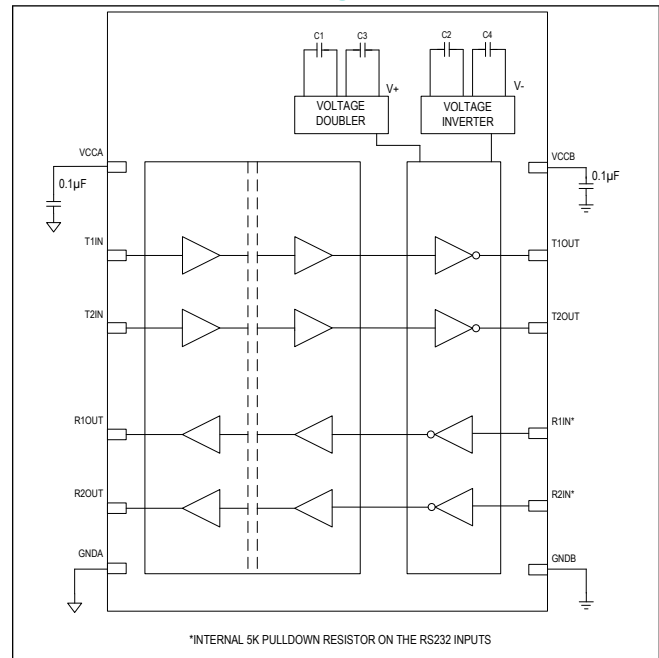

TABLE OF CONTENTS

General Description	1
Applications	1
Benefits and Features	1
Simplified Block Diagram	1
Absolute Maximum Ratings	4
Package Information	4
LGA-12	4
Electrical Characteristics	4
Typical Operating Characteristics	7
Pin Configurations	9
MAX33250E	9
MAX33251E	10
Pin Description	10
Detailed Description	11
Digital Isolation	11
Dual Charge Pump Voltage Converter and Inverter	11
Startup and Undervoltage Lockout	11
RS-232 Transmitters	11
RS-232 Receivers	11
Power Supply Decoupling	12
Insulation and Safety Characteristics	13
Typical Application Circuit	14
Ordering Information	15
Revision History	16

MAX33250E/MAX33251E 600V Isolated 2Tx/2Rx and 1Tx/1Rx RS-232
Transceiver with ±15kV ESD
and Integrated Capacitors

LIST OF TABLES

Table 1. Output Control Truth Table 11

Absolute Maximum Ratings

V _{CCA} to GNDA	-0.3V to +6V	Side B (V _{CCB}) to GNDB ESD	±2kV
V _{CCB} to GNDB	-0.3V to +6V	Side B (T1OUT, T2OUT, R1IN, R2IN) to GNDB ESD	HBM
T _{IN} to GNDA	-0.3V to +6V	±15kV
T _{OUT} to GNDB	±13.2V	Continuous Power Dissipation (Single Layer Board) (T _A = +70°C,	derate 10mW/°C above +70°C.)
R _{IN} to GNDB	±25V	510mW
R _{OUT} to GNDA	-0.3V to +6V	Continuous Power Dissipation (Multilayer Board) (T _A = +70°C,	derate 10mW/°C above +70°C.)
Short-Circuit Duration (T _{OUT} to GNDB)	Continuous	700mW
Short-Circuit Duration (R _{OUT} to GNDA)	Continuous	Operating Temperature Range	-40°C to +85°C
Side A (V _{CCA} , T1IN, T2IN, R1OUT, R2OUT) to GNDA	ESD		±2kV

Stresses beyond those listed under "Absolute Maximum Ratings" may cause permanent damage to the device. These are stress ratings only, and functional operation of the device at these or any other conditions beyond those indicated in the operational sections of the specifications is not implied. Exposure to absolute maximum rating conditions for extended periods may affect device reliability.

Package Information

LGA-12

Package Code	L1266M+1
Outline Number	21-100222
Land Pattern Number	90-100078
Thermal Resistance, Single-Layer Board:	
Junction-to-Ambient (θ _{JA})	157°C/W
Junction-to-Case Thermal Resistance (θ _{JC})	31°C/W
Thermal Resistance, Four-Layer Board:	
Junction-to-Ambient (θ _{JA})	115°C/W
Junction-to-Case Thermal Resistance (θ _{JC})	31°C/W

For the latest package outline information and land patterns (footprints), go to www.maximintegrated.com/packages. Note that a "+", "#", or "-" in the package code indicates RoHS status only. Package drawings may show a different suffix character, but the drawing pertains to the package regardless of RoHS status.

Package thermal resistances were obtained using the method described in JEDEC specification JESD51-7, using a four-layer board. For detailed information on package thermal considerations, refer to www.maximintegrated.com/thermal-tutorial.

Electrical Characteristics

(V_{CCA} - V_{GNDA} = 3.0V to 5.5V, V_{CCB} - V_{GNDB} = 3.0V to 5.5V, T_A = T_{MIN} to T_{MAX}, unless otherwise noted. Typical values are at V_{CCA} - V_{GNDA} = 3.3V, V_{CCB} - V_{GNDB} = 3.3V, V_{GNDA} = V_{GNDB}, and T_A = +25°C. (Note 1). Limits are 100% tested at T_A = +25°C. Limits over the operating temperature range and relevant supply voltage range are guaranteed by design and characterization. Specifications marked "GBD" are guaranteed by design and not production tested.)

PARAMETER	SYMBOL	CONDITIONS	MIN	TYP	MAX	UNITS
POWER						
Supply Voltage	V _{CCA} , V _{CCB}		3.0		5.5	V
Supply Current	I _{CCA}	V _{CCA} = 5V, R _{IN} and T _{IN} idle			12	mA
		V _{CCA} = 3.3V, R _{IN} and T _{IN} idle			10	
	I _{CCB}	V _{CCB} = 5V, R _{IN} and T _{IN} idle, no load			12	
		V _{CCB} = 3.3V, R _{IN} and T _{IN} idle, no load			10	

Electrical Characteristics (continued)

($V_{CCA} - V_{GNDA} = 3.0\text{V}$ to 5.5V , $V_{CCB} - V_{GNDB} = 3.0\text{V}$ to 5.5V , $T_A = T_{MIN}$ to T_{MAX} , unless otherwise noted. Typical values are at $V_{CCA} - V_{GNDA} = 3.3\text{V}$, $V_{CCB} - V_{GNDB} = 3.3\text{V}$, $V_{GNDA} = V_{GNDB}$, and $T_A = +25^\circ\text{C}$. (Note 1). Limits are 100% tested at $T_A = +25^\circ\text{C}$. Limits over the operating temperature range and relevant supply voltage range are guaranteed by design and characterization. Specifications marked "GBD" are guaranteed by design and not production tested.)

PARAMETER	SYMBOL	CONDITIONS	MIN	TYP	MAX	UNITS
Undervoltage-Lockout Threshold	V_{UVLO}	$V_{CCA} - V_{GNDA}$ (Note 2)		2.0		V
Undervoltage-Lockout Hysteresis	$V_{UVLOHYS}$	$V_{CCA} - V_{GNDA}$ (Note 2)		0.1		V
INPUT INTERFACE (T_IN, R_IN)						
Input Low Voltage	V_{IL}	T_IN relative to GNDA			0.8	V
		R_IN relative to GNDB, $T_A = 25^\circ\text{C}$, $V_{CC} = 3.3\text{V}$			0.6	
		R_IN relative to GNDB, $T_A = 25^\circ\text{C}$, $V_{CC} = 5\text{V}$			0.8	
Input High Voltage	V_{IH}	T_IN relative to GNDA	$0.7 \times V_{CCA}$			V
		R_IN relative to GNDB, $V_{CCB} = 3.3\text{V}$ and 5V , $T_A = 25^\circ\text{C}$	2.4			
Transmitter Input Hysteresis		(T_IN)		0.5		V
Receiver Input Hysteresis		(R_IN)		0.5		V
Transmitter Input Leakage		(T_IN)			± 1	μA
Input Resistance (R_IN)		$T_A = 25^\circ\text{C}$	3	5	7	k Ω
RECEIVER OUTPUT INTERFACE (R_OUT)						
Output Low Voltage	V_{OL}	R_OUT relative to GNDA, sink current = 4mA			0.8	V
Output High Voltage	V_{OH}	R_OUT relative to GNDA, source current = 4mA	$V_{CCA} - 0.4$			V
Output Short-Circuit Current					± 110	mA
TRANSMITTER OUTPUT (T_OUT)						
Output Voltage Swing		T_OUT loaded with 3k Ω to GNDB	± 5			V
Output Resistance		$V_{CCB} = 0\text{V}$, transmitters = $\pm 2\text{V}$	300	10M		Ω
Output Short-Circuit Current					± 70	mA
Output Leakage Current		$V_{CCB} = 0\text{V}$, $V_{OUT} = \pm 12\text{V}$			± 25	μA
ESD AND ISOLATION PROTECTION						
ESD for R_IN, T_OUT		IEC 61000-4-2 Air Discharge			± 12	kV
		IEC 61000-4-2 Contact Discharge			± 6	
		ESD Human Body Model JEDEC JS-001-2014			± 15	
Isolation Voltage	V_{ISO}	t = 60s (Note 3)		600		V_{RMS}

Electrical Characteristics (continued)

($V_{CCA} - V_{GNDA} = 3.0\text{V}$ to 5.5V , $V_{CCB} - V_{GNDB} = 3.0\text{V}$ to 5.5V , $T_A = T_{MIN}$ to T_{MAX} , unless otherwise noted. Typical values are at $V_{CCA} - V_{GNDA} = 3.3\text{V}$, $V_{CCB} - V_{GNDB} = 3.3\text{V}$, $V_{GNDA} = V_{GNDB}$, and $T_A = +25^\circ\text{C}$. (Note 1). Limits are 100% tested at $T_A = +25^\circ\text{C}$. Limits over the operating temperature range and relevant supply voltage range are guaranteed by design and characterization. Specifications marked "GBD" are guaranteed by design and not production tested.)

PARAMETER	SYMBOL	CONDITIONS	MIN	TYP	MAX	UNITS
Working Isolation Voltage	V_{IOWM}	> 50 years (Note 3)		200		V_{RMS}
TIMING CHARACTERISTICS						
Maximum Data Rate		$V_{CCB} = 5\text{V}$, $R_L = 3\text{k}\Omega$, $C_L = 1000\text{pF}$	1000			kbps
Receiver Propagation Delay	t_{PHL} , t_{PLH}	R_IN to R_OUT, $C_L = 150\text{pF}$		0.15		μs
Transmitter Skew	$ t_{PHL} - t_{PLH} $ (Note 4)			35		ns
Receiver Skew	$ t_{PHL} - t_{PLH} $			60		ns
Transition-Region Slew Rate		$V_{CCA} = V_{CCB} = 3.3\text{V}$, $T_A = +25^\circ\text{C}$, $R_L = 3\text{k}$ to 7k , $C_L = 150\text{pF}$ to 1000pF , measured from $+3\text{V}$ to -3V or -3V to $+3\text{V}$	24		150	$\text{V}/\mu\text{s}$

Note 1: All units are production tested at $T_A = 25^\circ\text{C}$. Specifications over temperature are guaranteed by design. All voltages of side A are referenced to GNDA. All voltages of side B are referenced to GNDB.

Note 2: The undervoltage lockout threshold and hysteresis guarantee that the outputs are in a known state when the supply voltage dips.

Note 3: The isolation is guaranteed by design and not production tested.

Note 4: Transmitter skew is measured at the transmitter zero cross points.

Typical Operating Characteristics

($V_{DD} = 5\text{V}$, $V_L = 3.3\text{V}$, $R_L = 60\Omega$, $C_L = 15\text{pF}$, $T_A = +25^\circ\text{C}$, unless otherwise noted.)

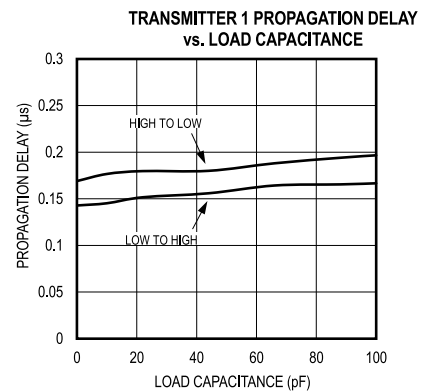
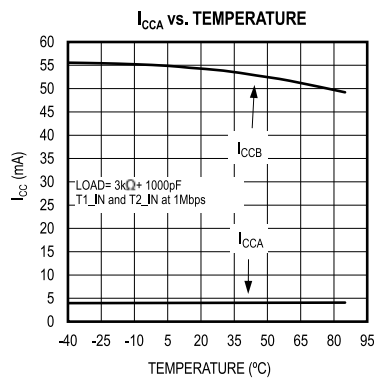
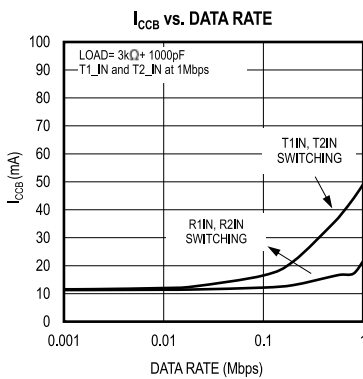
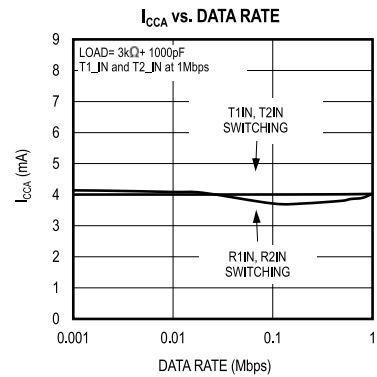
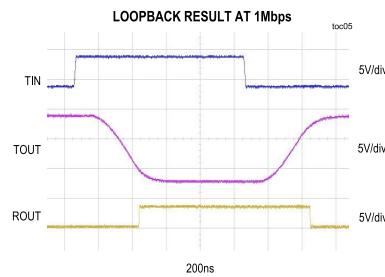
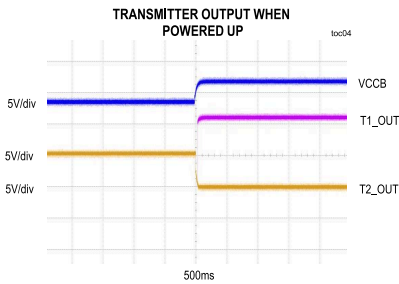
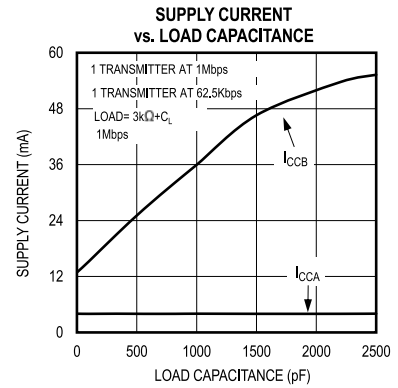
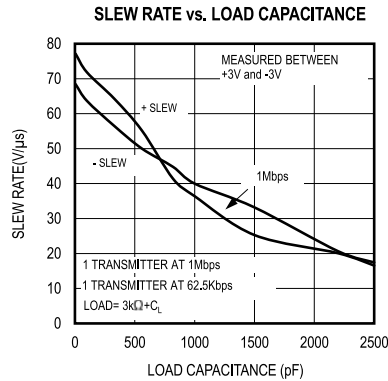
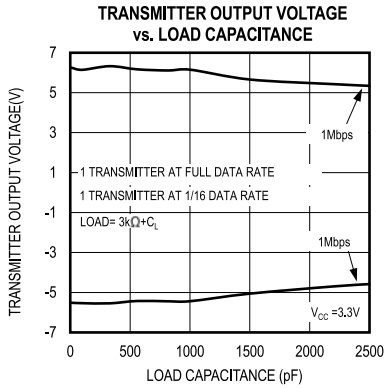

Typical Operating Characteristics (continued)

($V_{DD} = 5V$, $V_L = 3.3V$, $R_L = 60\Omega$, $C_L = 15pF$, $T_A = +25^\circ C$, unless otherwise noted.)

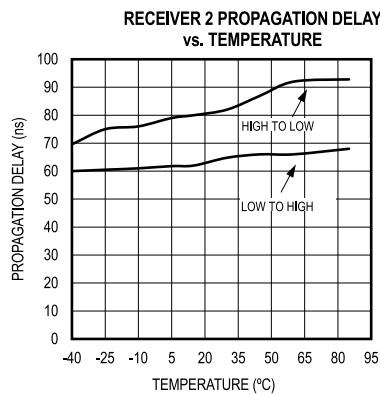
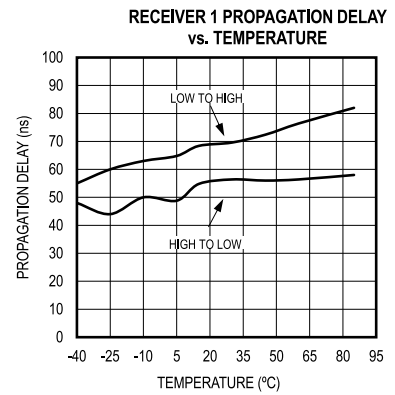
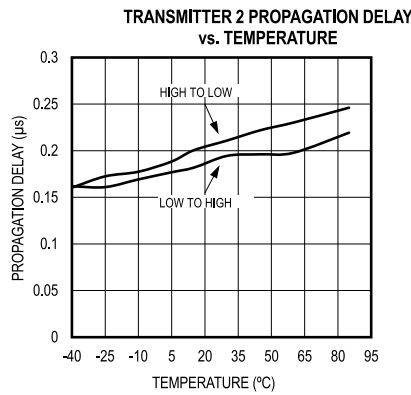
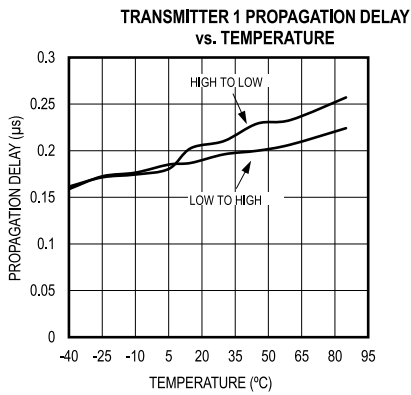
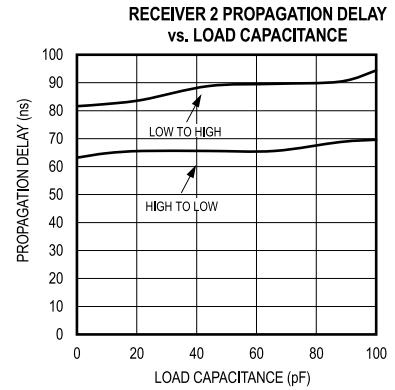
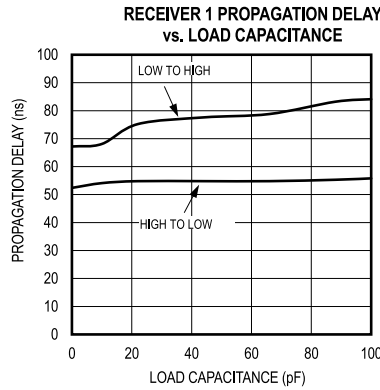
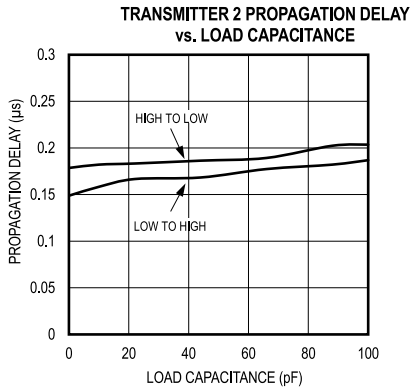

Pin Configurations

MAX33250E

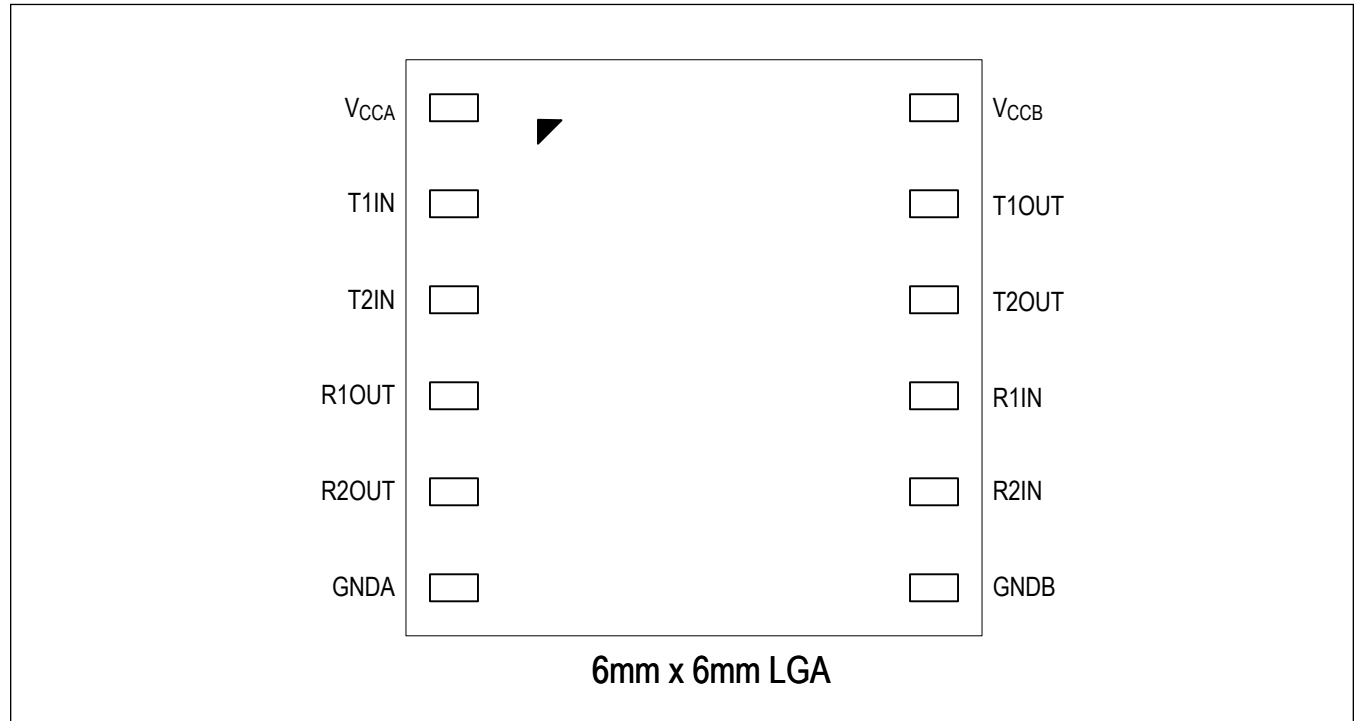

MAX33251E

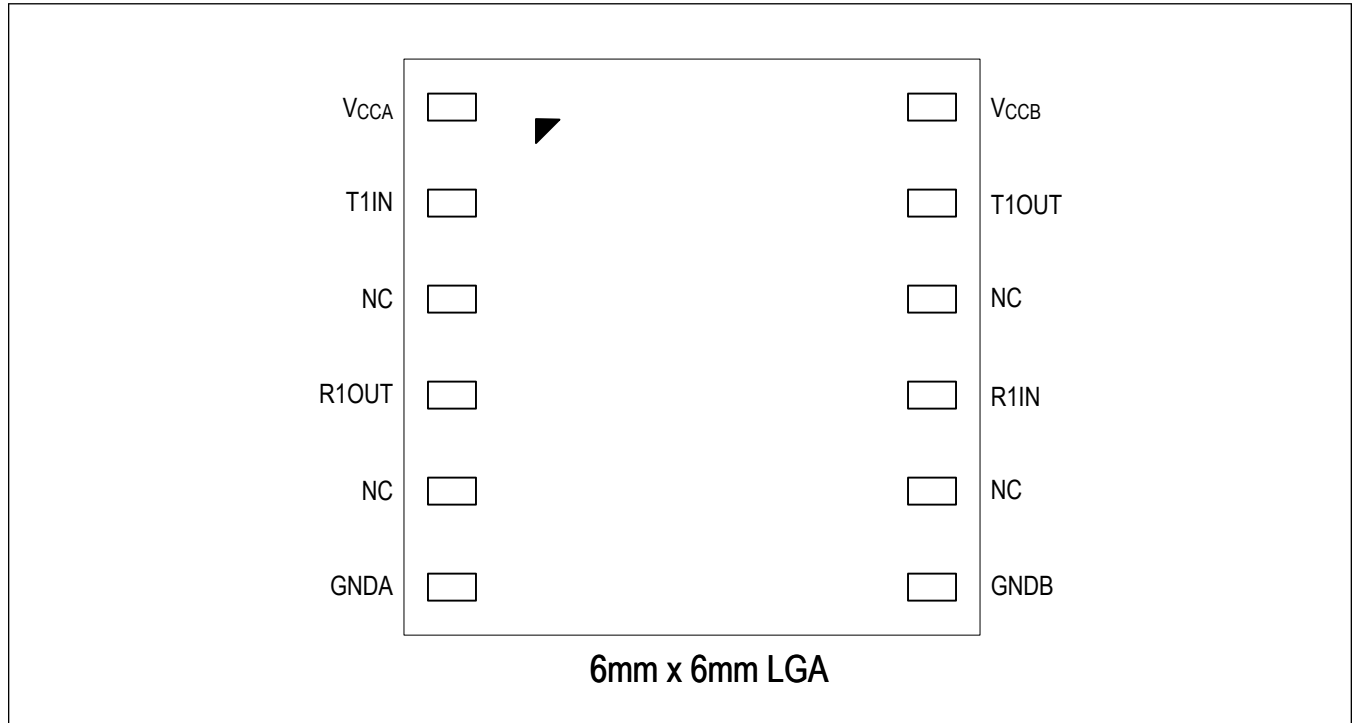

Pin Description

PIN		NAME	FUNCTION
MAX33250E	MAX33251E		
1	1	V _{CCA}	Supply Voltage of Logic Side A. Bypass V _{CCA} with a 0.1µF ceramic capacitor to GNDA
2	2	T1IN	TTL/CMOS Transmitter Input 1
3	---	T2IN	TTL/CMOS Transmitter Input 2
4	4	R1OUT	TTL/CMOS Receiver Output 1
5	---	R2OUT	TTL/CMOS Receiver Output 2
6	6	GNDA	Ground for Logic Side A
7	7	GNDB	Ground for Field Side B
8	---	R2IN	RS-232 Receiver Input 2
9	9	R1IN	RS-232 Receiver Input 1
10	---	T2OUT	RS-232 Transmitter Output 2
11	11	T1OUT	RS-232 Transmitter Output 1
12	12	V _{CCB}	Supply Voltage of Logic Side B. Bypass V _{CCB} with a 0.1µF ceramic capacitor to GNDB

Detailed Description

The MAX33250E and MAX33251E are 1Mbps, 600V_{RMS} isolated RS-232 transceivers. The MAX33250E has 2 transmitters and 2 receivers (2Tx/2Rx), and the MAX33251E has 1 transmitter and 1 receiver (1Tx/1Rx). The isolation is provided by Maxim's proprietary insulation material that can withstand 600V_{RMS} for 60 seconds. The MAX33250E and MAX33251E conform to the EIA/TIA-232 standard and operates at data rates up to 1Mbps over the temperature range of -40°C to 85°C .

Digital Isolation

The MAX33250E and MAX33251E provide galvanic isolation and protection for digital signals from the local microcontroller's logic UART port (primary side) to the field lines (secondary side). A capacitive design is utilized where the insulation material for the isolation barrier is rated for 600V_{RMS} withstand voltage (V_{ISO}) for 60 seconds. The same material can also be exposed to a differential of 200V_{RMS} of working voltage (V_{IOWM}) for more than 50 years, providing longevity for many different types of end equipment. The isolation barrier also breaks ground loops and level translation for two different systems where it could potentially create inadvertent or misinterpret data signals.

Dual Charge Pump Voltage Converter and Inverter

Both parts have internal RS-232 power supplies that consist of a regulated dual charge pump that provides output voltages of $+5.5\text{V}$ (doubling charge pump) and -5.5V (inverting charge pump), over the $+3.0\text{V}$ to $+5.5\text{V}$ range. Each charge pump is internally connected to a pair of flying capacitors and a pair of reservoir capacitors to generate the internal V+ and V- supplies, as shown in [Typical Application Diagram](#).

Startup and Undervoltage Lockout

The V_{CCA} and V_{CCB} supplies are both internally monitored for undervoltage conditions. Undervoltage events can occur during power-up, power-down, or during normal operation due to a dip in either power supply line. When an undervoltage event is detected on either of the supplies, all outputs on both sides are automatically controlled, regardless of the status of the inputs.

Table 1. Output Control Truth Table

INPUTS	V_{CCA}	V_{CCB}	RxOUT	TxOUT
RxIN = 1	Undervoltage	Powered	High	—
RxIN = 0	Undervoltage	Powered	Follows V_{CCA}	—
TxIN = 1	Undervoltage	Powered	—	Low
TxIN = 0	Undervoltage	Powered	—	Low
RxIN = 1	Powered	Undervoltage	High	—
RxIN = 0	Powered	Undervoltage	High	—
TxIN = 1	Powered	Undervoltage	—	*Low
TxIN = 0	Powered	Undervoltage	—	*Low

*TxOUT will be out of compliance with the RS-232 specification as V_{CCB} falls below 2.9V.

RS-232 Transmitters

The transmitters are inverting level translators that convert CMOS-logic levels from the UART or equivalent output port to $+5\text{V}$ EIA/TIA-232 levels. The two devices guarantee 1Mbps with worst-case loads of $3\text{k}\Omega$ in parallel with 1000pF , providing compatibility with PC-to-PC communication software. Transmitters can be paralleled to drive multiple receivers.

RS-232 Receivers

The receivers convert RS-232 signals to CMOS-logic output levels to the UART or equivalent input port. The devices feature inverting outputs that always remain active.

MAX33250E/MAX33251E

600V Isolated 2Tx/2Rx and 1Tx/1Rx RS-232
Transceiver with $\pm 15\text{kV}$ ESD
and Integrated Capacitors

Power Supply Decoupling

To reduce ripple and the chance of introducing data errors, bypass V_{CCA} and V_{CCB} with $0.1\mu\text{F}$ ceramic capacitors to GND_A and GND_B, respectively. Place the bypass capacitors as close to the power-supply input pins as possible.

Insulation and Safety Characteristics

PARAMETER	SYMBOL	CONDITIONS	VALUE	UNIT
IEC INSULATION AND SAFETY RELATED FOR SPECIFICATIONS				
External Tracking (Creepage)	CPG	IEC 60664-1	4.4	mm
External Air Gap (Clearance)	CLR	IEC 60664-1	4.4	mm
Minimum Internal Gap		Insulation Thickness	0.0026	mm
Tracking Resistance (Comparative Tracking Index)	CTI	IEC 112/VDE 030 Part 1	175	V
Insulation Resistance Across Barrier	R_{ISO}		1	$G\Omega$
Capacitance Across Isolation Barrier	C_{IO}	$f = 1\text{MHz}$	12	pF
VDE IEC INSULATION CHARACTERISTICS				
Surge Isolation Voltage	V_{IOSM}	IEC 60747-17, section 5.3.1.6 and 5.4.6 for basic insulation	1	kV_{PEAK}
Repetitive Peak Isolation Voltage	V_{IORM}	IEC 60747-17, section 5.3.1.3	282	kV_{PEAK}
Rated Transient Isolation Voltage	V_{IOTM}	IEC 60747-17, section 5.3.1.4	850	kV_{PEAK}
Safety Limiting Temperature	T_S	IEC 60747-17, section 7.2.1	150	$^{\circ}\text{C}$
Safety Limiting Side A Power Dissipation	P_{SA}	IEC 60747-17, section 7.2.1	0.75	W
Safety Limiting Side B Power Dissipation	P_{SB}	IEC 60747-17, section 7.2.1	0.75	W
Apparent Charge Method	q_{pd}	IEC 60747-17, section 7.4 method a and b	5	pC
Overvoltage Category		IEC 60664-1, single or three phase 50V DC or AC	I,II	—
Overvoltage Category		IEC 60664-1, single or three phase 100V DC or AC	I	—
Climatic Category			40/125/21	—
Pollution Degree		DIN VDE 0110	2	—

Typical Application Circuit

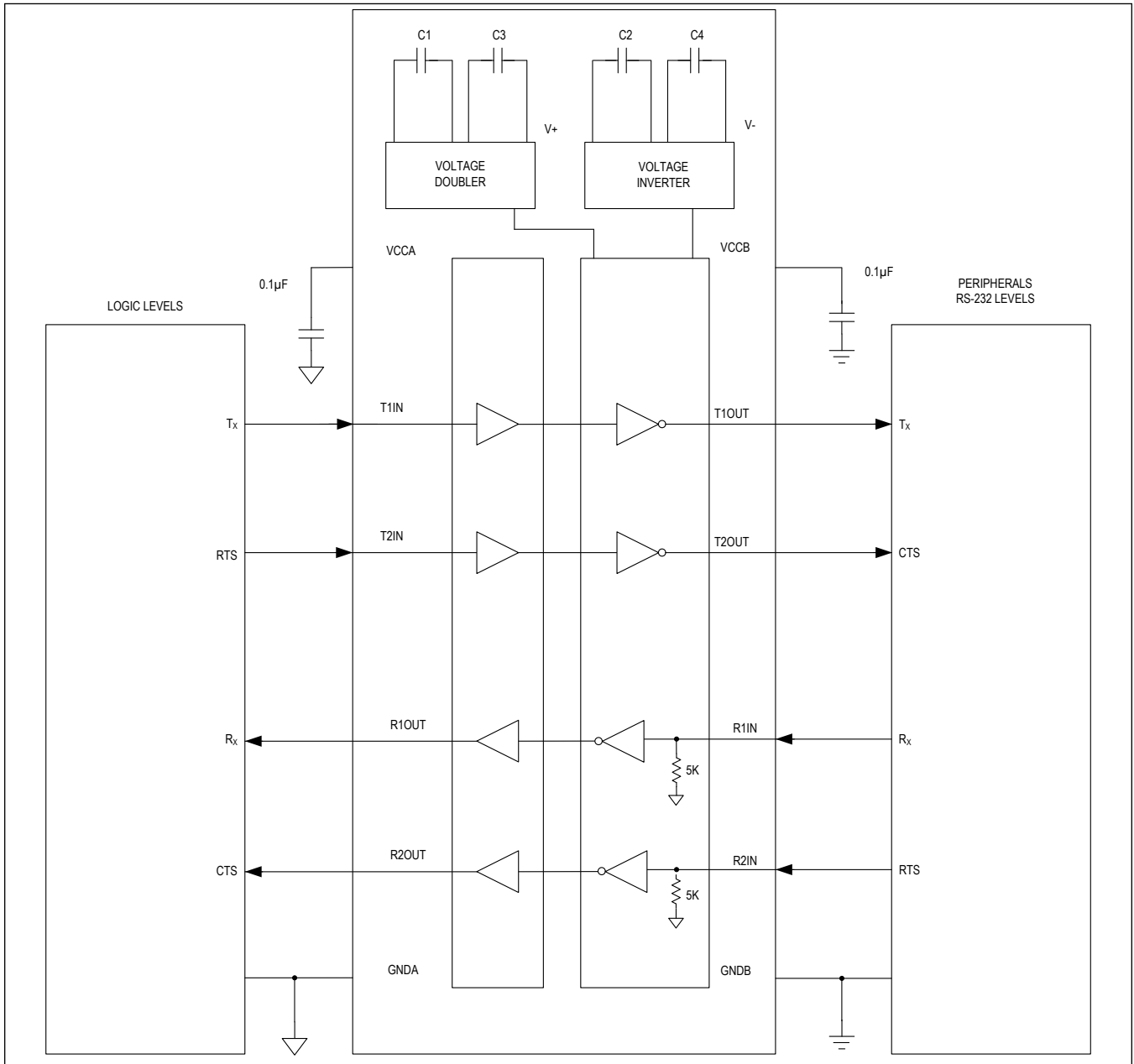

MAX33250E/MAX33251E

600V Isolated 2Tx/2Rx and 1Tx/1Rx RS-232
Transceiver with $\pm 15\text{kV}$ ESD
and Integrated Capacitors

Ordering Information

PART NUMBER	TEMPERATURE RANGE	CHANNEL-CONFIGURATION	DATA RATE	PIN-PACKAGE
MAX33250EELC+	-40°C to +85°C	2 Transmitters, 2 Receivers	1Mbps	12 (6mm x 6mm) LGA
MAX33251EELC+	-40°C to +85°C	1 Transmitter, 1 Receiver	1Mbps	12 (6mm x 6mm) LGA

+Denotes a lead(Pb)-free/RoHS-compliant package.

T = Tape-and-reel.

MAX33250E/MAX33251E

600V Isolated 2Tx/2Rx and 1Tx/1Rx RS-232
Transceiver with $\pm 15\text{kV}$ ESD
and Integrated Capacitors

Revision History

REVISION NUMBER	REVISION DATE	DESCRIPTION	PAGES CHANGED
0	9/18	Initial release	—
1	11/18	Updated <i>Ordering Information</i>	13
2	8/21	Updated <i>Typical Operating Characteristics</i> section	7, 8

For pricing, delivery, and ordering information, please visit Maxim Integrated's online storefront at <https://www.maximintegrated.com/en/storefront/storefront.html>.

Maxim Integrated cannot assume responsibility for use of any circuitry other than circuitry entirely embodied in a Maxim Integrated product. No circuit patent licenses are implied. Maxim Integrated reserves the right to change the circuitry and specifications without notice at any time. The parametric values (min and max limits) shown in the Electrical Characteristics table are guaranteed. Other parametric values quoted in this data sheet are provided for guidance.

Mouser Electronics

Authorized Distributor

Click to View Pricing, Inventory, Delivery & Lifecycle Information:

[MAX33250EELC+](#) [MAX33250EELC+T](#)